

- Description:** High efficiency LED decorative pendant mount luminaire with machined aluminum housing and clear acrylic light control lens.
- Lamping:** Single 4 watt warm dimmable LED, 400 lumens, 95 CRI, 3000K to 1800K (3W) smooth CCT dimming transition. 90 CRI, 2700K (27), 3000K (30), 3500K (35) color temperature options are optional. Color consistent from LED to LED within a 3 step MacAdam ellipse.
- Electrical:** Constant current class 2 driver, 120/277V 50/60Hz, (sold separate). See D8\_250 series remote driver spec sheets for details.
- Function:** Canopy and mounting plate provided. Mounts directly to 4" octagonal j-box (by others) 120"(3048mm) suspension cable provided standard. Field adjustable. Blank canopies (BC) optional (sold separate).
- Metal finish:** Clear anodized aluminum (S)  
Black anodized aluminum (B)  
Gold anodized aluminum (G)  
Champagne anodized aluminum (C)
- Light Distribution Optics:** Clear acrylic light control lens with diffuse light distribution aperture (CD) or optional satin light control lens with diffuse light distribution aperture (SD)
- Approvals:** Dry locations, approved to UL safety standards for luminaires when used with Archilume D8\_250 series drivers.
- Order Code:** P1D-AU- \_\_\_\_\_ - \_\_\_\_\_ - \_\_\_\_\_
- |             |             |                                |
|-------------|-------------|--------------------------------|
| 3W warm dim | S silver    | CD clear lens diffuse aperture |
| 27 2700K    | B black     | SD satin lens diffuse aperture |
| 30 3000K    | G gold      |                                |
| 35 3500K    | C champagne |                                |

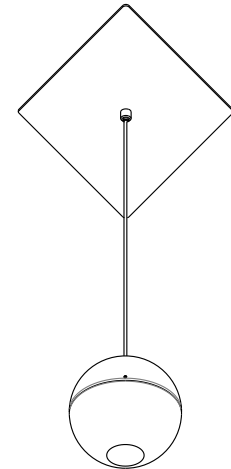

12.75" x 7.50"  
324mm x 191mm



120"  
3048mm  
variable

3.8"  
97mm

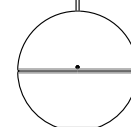

Ø 4"  
Ø 102mm

Blank Canopy

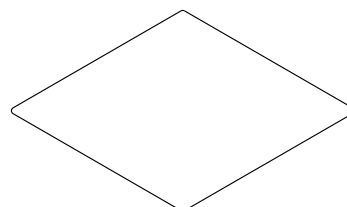

7.50"  
191mm

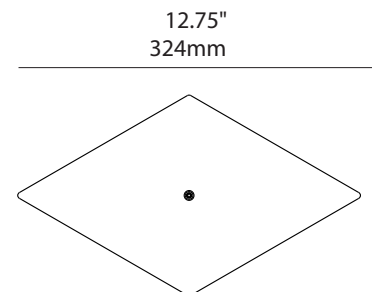

12.75"  
324mm

**Description:** Remote Mounted Electronic Driver - Suitable for operation of 1 to 3 Archilume warm dimmable lamp heads. Suitable for remote mounting up to 25 feet.

**Electrical:** 15 watt, 120-277V 50/60Hz input, 250mA constant current class 2 output. Class A sound rating. Short circuit protection. The violet (positive) and the gray (negative) leads provided are for use with 0-10V DC type dimmers and controls.

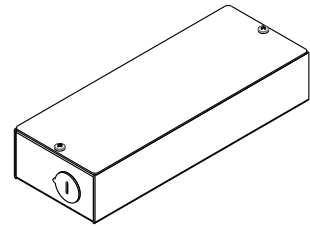

**Compatible 0-10V dimmers and switches:** Leviton IllumaTech - IP710-DLX  
Lutron Nova T - NTFTV  
Lutron Diva - DVTV  
Lutron Diva - NFTV  
Watt Stoper DCLV1  
Pass and Seymour (Legrand) CD4FB-W

**Compatible dimming control systems:** Lutron GraphicEye - GRX-TVI w GRX3503  
Lutron Energy Savr Node - QSN-4T16-S  
Lutron TVM2 Module  
Crestron GLX-DIMFLV8  
Crestron GLXP-DIMFLV8  
Crestron GLPAC-DIMFLV4-\*  
Crestron GLPAC-DIMFLV8-\*  
Crestron GLPP-DIMFLVEX-PM  
Crestron GLPP-1DIMFLV2EX-PM  
Crestron GLPP-1DIMFLV3EX-PM  
Crestron DIN-AO8  
Crestron DIN-4DIMFLV4  
Crestron CLS-EXP-DIMFLV  
Crestron CLCI-1DIMFLV2EX

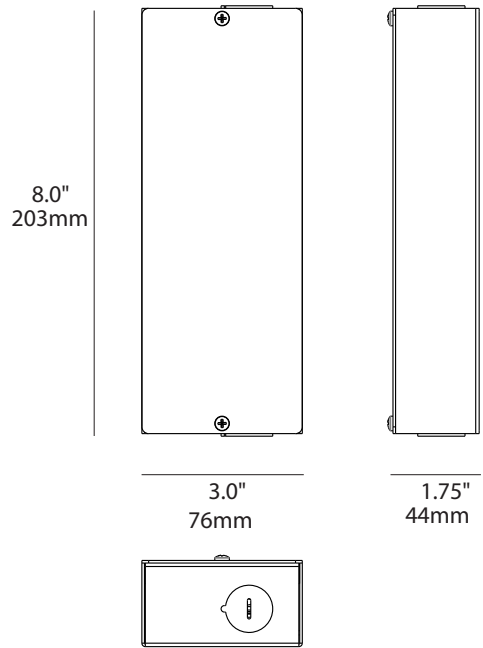

**Mounting:** Mounts from inside box with (2) #10 screws (by others). Mounting holes are on the centerline on 6.75" (171mm) centers.

**Remote Box Finish:** Galvanized metal.

**Approvals:** Dry locations, approved to UL safety standards for luminaires.

**Order Code:** D8-250-010

**Description:** Remote Mounted Electronic Driver - Suitable for operation of 1 to 3 Archilume lamp heads. Suitable for remote mounting up to 25 feet.

**Electrical:** 20 watt, 120-277V 50/60Hz input, 250mA constant current class 2 output. Class A sound rating. Short circuit protection. The positive and negative control leads provided are for use with Dali-2 type control systems.

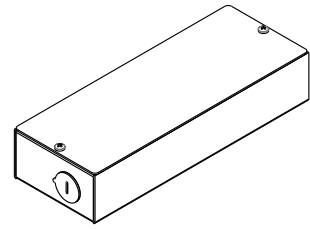

**Control protocol:** DALI-2 Device Type 6

**Mounting:** Mounts from inside box with (2) #10 screws (by others). Mounting holes are on the centerline on 6.75" (171mm) centers.

**Remote Box Finish:** Galvanized metal.

**Approvals:** Dry locations, approved to UL safety standards for luminaires.

**Order Code:** D8-250-DALI

8.0"  
203mm

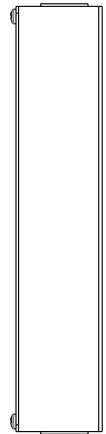
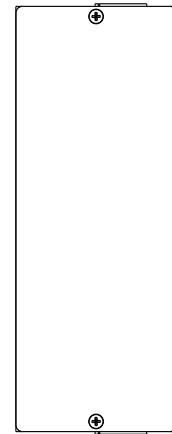

3.0"  
76mm

1.75"  
44mm

