

- Description:** Human centric OLED decorative pendant mount luminaire with machined aluminum housing and naturally diffuse light source.
- Lamping:** 3 watt dimmable OLED, 200 lumens, 3000K (30), 90 CRI, R9 >50. OLED is a light source that provides soft yet bright full spectrum illumination resulting in an artificial light that resembles daylight.
- Electrical:** Constant current class 2 driver, 120/277V 50/60Hz, (sold separate). See D8_150 series remote driver spec sheets for details.
- Function:** Canopy and mounting plate provided. Mounts directly to 4" octagonal j-box (by others) 120"(3048mm) suspension cable provided standard. Field adjustable. Blank canopies (BC) optional (sold separate).
- Metal finish:** Clear anodized aluminum (S)
Black anodized aluminum (B)
Gold anodized aluminum (G)
Champagne anodized aluminum (C)
- Light Distribution:** Soft brightness naturally diffuse light source
- Approvals:** Dry locations, approved to UL safety standards for luminaires when used with Archilume D8_150 series drivers.
- Order Code:** P1C-OV-_____ - _____

30 3000K S silver
BC blank B black
G gold
C champagne

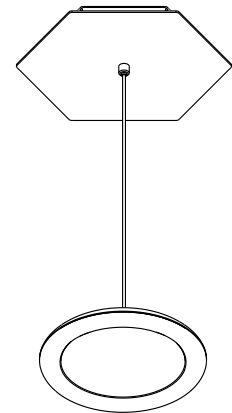

7.50" x 6.50"
191mm x 165mm

120"
3048mm
variable

1.3"
33mm

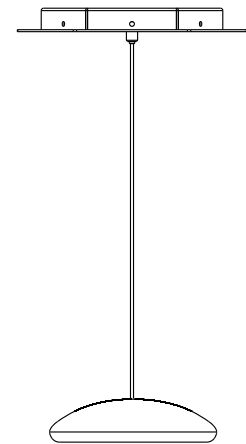

Ø 5"
Ø 27mm

7.50"
191mm

Blank Canopy

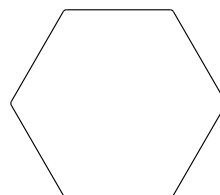

6.50"
165mm

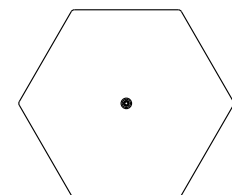

Description: Remote Mounted Electronic Driver - Suitable for operation of 1 to 2 Archilume Ovolo dimmable lamp heads. Suitable for remote mounting up to 25 feet.

Electrical: 8 watt, 120-277V 50/60Hz input, 150mA constant current class 2 output. Class A sound rating. Short circuit protection. The violet (positive) and the gray (negative) leads provided are for use with 0-10V DC type dimmers and controls.

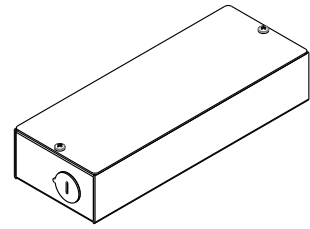

Compatible 0-10V dimmers and switches: Leviton IllumaTech - IP710-DLX
Lutron Nova T - NTFTV
Lutron Diva - DVTV
Lutron Diva - NFTV
Watt Stoper DCLV1
Pass and Seymour (Legrand) CD4FB-W

Compatible dimming control systems: Lutron GraphicEye - GRX-TVI w GRX3503
Lutron Energy Savr Node - QSN-4T16-S
Lutron TVM2 Module
Crestron GLX-DIMFLV8
Crestron GLXP-DIMFLV8
Crestron GLPAC-DIMFLV4-*
Crestron GLPAC-DIMFLV8-*
Crestron GLPP-DIMFLVEX-PM
Crestron GLPP-1DIMFLV2EX-PM
Crestron GLPP-1DIMFLV3EX-PM
Crestron DIN-AO8
Crestron DIN-4DIMFLV4
Crestron CLS-EXP-DIMFLV
Crestron CLCI-1DIMFLV2EX

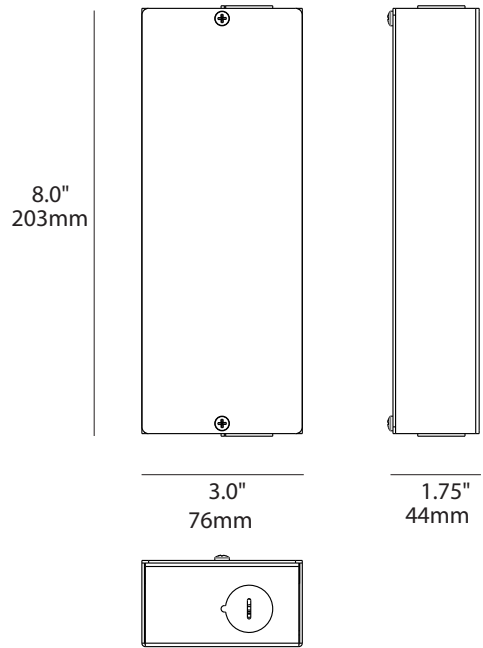

Mounting: Mounts from inside box with (2) #10 screws (by others). Mounting holes are on the centerline on 6.75" (171mm) centers.

Remote Box Finish: Galvanized metal.

Approvals: Dry locations, approved to UL safety standards for luminaires.

Order Code: D8-150-010

Description: Remote Mounted Electronic Driver - Suitable for operation of 1 to 2 Archilume lamp heads. Suitable for remote mounting up to 25 feet.

Electrical: 20 watt, 120-277V 50/60Hz input, 150mA constant current class 2 output. Class A sound rating. Short circuit protection. The positive and negative control leads provided are for use with Dali-2 type control systems.

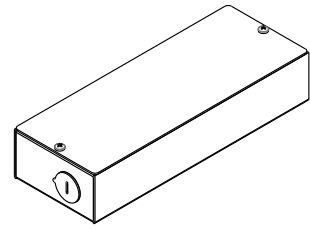

Control protocol: DALI-2 Device Type 6

Mounting: Mounts from inside box with (2) #10 screws (by others). Mounting holes are on the centerline on 6.75" (171mm) centers.

Remote Box Finish: Galvanized metal.

Approvals: Dry locations, approved to UL safety standards for luminaires.

Order Code: D8-150-DALI

8.0"
203mm

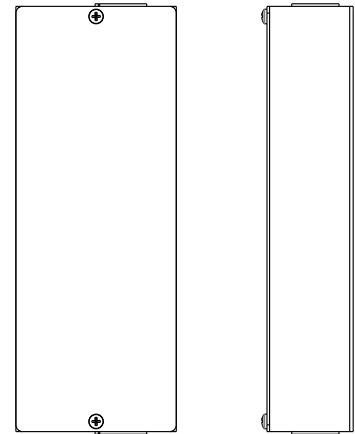

3.0"
76mm

1.75"
44mm

